



DIRECT
SUPPLY INC
SURFACE MATERIALS \ CABINETS \ HARDWARE

■ Stocking Program

■ ■
SUGATSUNE
■ ■

A Pocket Door System

Like No Other!

ALT-ST15/20 POCKET DOOR SYSTEM

Available in OVERLAY and INSET configurations.

- This system allows doors to retract inside cabinets. Doors will not occupy space, providing full access to inside of cabinets.
- Pocket Door System with door alignment adjustability. Featuring Olympia soft-close hinges with 5-speed precision adjustability for door closing speed.
- The hanging angle of the door can be easily adjusted to prevent door sag. When installing, the door can be lifted upward into 5 different angles.
- Successfully passed 40,000 open/close cycles.

	ALT-ST15-D360L (4 slides)	ALT-ST20-D360LL (4 slides)
Door Width	Max. 24" (610 mm)	
Door Height	35-7/16"~47-1/4" (900 - 1200 mm)	78-3/4"~94-1/2" (2000 - 2400 mm)
Door Thickness	11/16"~1-3/16" (18 - 30 mm)	
Door Weight	Max. 33 lbs (15 kg)	Max. 44 lbs (20 kg)

Easy Door Alignment Adjustment

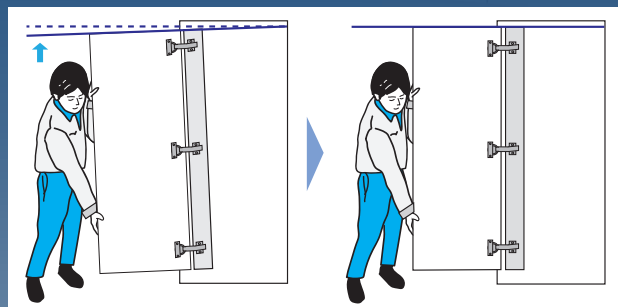

When installing, you can adjust the hanging angle just by lifting up the door.



TABLE OF CONTENTS

2	SLIDING DOOR HARDWARE
3	HANDLES & PULLS
4-5	CATCHES & LATCHES
5-7	DOOR & CABINET HINGES
6	DOOR STRAIGHTENERS
7-8	LID SUPPORTS
8	LATERAL OPENING

8	DRAWER SLIDES
9	STAINLESS STEEL HOOKS
9	LEVELING GLIDES
10	SHELF & SUPPORT
10	DAMPERS
10	PANEL MOUNTING SYSTEMS

SLIDING DOOR HARDWARE

FD80 POCKET DOOR SYSTEM



	FD80PD-RM2-RT Recessed Mount	FD80PD-SM2-RT Surface Mount
Roller	Top Recessed on Door	Top Surface on Door
Track Mounting	Ceiling	
Door Weight	Min. 77 lbs (35 kg)	
	Max. 176 lbs (80 kg)	
Door Thickness	Recessed: 1-5/16" (34 mm)	Surface: 1-3/16" (30 mm)
Door Width	If less than 98-7/16" (2500 mm) 30-7/8" ~ 59-1/16" (784 ~ 1500 mm)	
	If greater than 98-7/16" (2500 mm) 33-7/16" ~ 59-1/16" (850 ~ 1500 mm)	
Door Height	Max. 106-5/16" (2700 mm)	

- Load capacity: 176 lbs (80 kg).
- Use with removable jamb/trim/casing.
- Easy installation, adjustments and maintenance.
- Built-in soft-close and soft-open damper prevents slamming.
- Two-rail system, allows all components to be fixed or adjusted through the opening without breaking the pocket.
- Rollers are **recessed or surface** mounted to top of door.
- High durability, passed 200,000 cycle test (private).
- For interior use only.

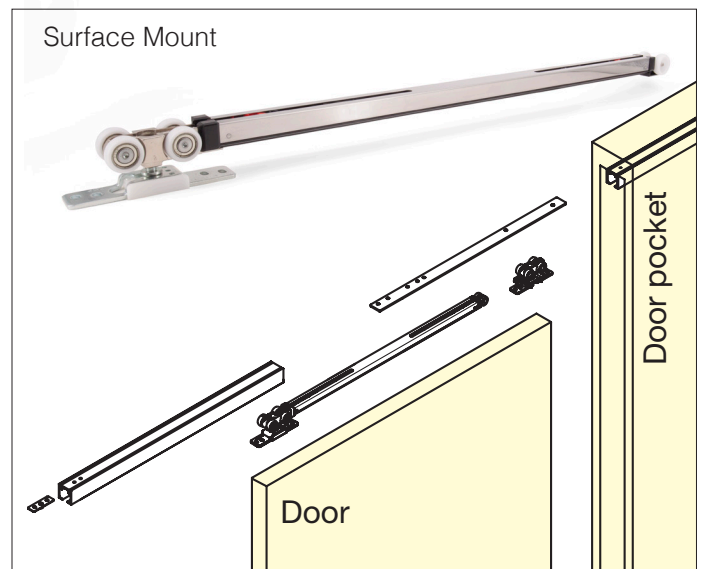
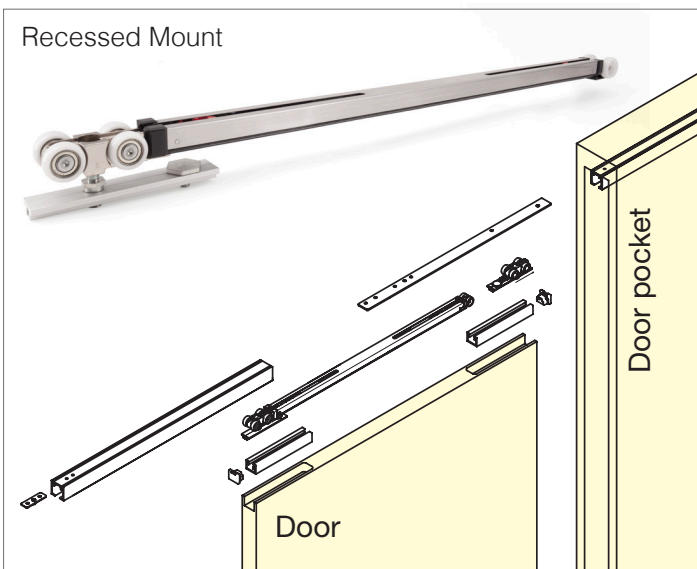

SLIDING DOOR HARDWARE

HANDLES

CATCHES & LATCHES

HINGES

LID SUPPORTS

LATERAL OPENING

DRAWER SLIDES

HOOKS

LEVELING GLIDES

SHELF & SUPPORT

DAMPERS

PANEL MOUNTING



Type	SDR-RA80-SM	
	Surface Mount Sliding Door	
Roller	Top Surfaced	
Track Mounting	Ceiling	Wall w/Continuous Bracket
Door Weight	Max. 200lbs (90 kg)	
Door Thickness	Min. 1-1/8"(28 mm)	
Door Width	Two-Way Soft Close Min. 33-7/16" (850 mm) Standard Close Min. 25-9/16" (650 mm)	

- 200lbs (90kg)
- Ceiling and Barn Door Mount
- Surface Mounted door brackets
- Double rollers with ball bearings
- Quiet precision movement
- Soft Close Feature
- Vertical Adjustment $\pm 1/16"$ (1mm)

SLIDING DOOR HARDWARE

Image	Part No.	Description	Finish	Image	Part No.	Description
	SDR-RA80-2000	2000mm Sliding Door Track	Aluminum		SDR-RA80-8006	Soft-close Sliding Door Rollers
	SDR-RA80-3000	3000mm Sliding Door Track	Aluminum		SDR-RA80-SM-KIT	Sliding Door Surface Mount Kit

SLIDING DOOR LATCHES

Image	Part No.	Description	Finish	Image	Part No.	Description	Finish
	HC-3051-CLD-NI	Sliding Door Latch (Cylinder Lock)	Polished		HC-30	Sliding Door Latch	Satin
	HC-3051-IND-NI	Sliding Door Latch (Indicator)	Polished		HC-30R	Sliding Door Latch	Satin
	HC-3051-DSL-NI	Sliding Door Latch (Double Sliding)	Polished		HC-30L	Sliding Door Latch	Satin
	HC-3051-PRV-NI	Sliding Door Latch (Privacy)	Polished				









SLIDING DOOR HANDLES

Image	Part No.	Description	Finish	Image	Part No.	Description	Finish
	DSI-3250-35	S/S Sliding Door Handle	Satin		DSI-4251-35	S/S Sliding Door Handle	Satin





HANDLE PULLS

Image	Part No.	Description	Finish
	UT-105/S-1	Recessed Pull	Satin

MAGNETIC CATCHES

Image	Part No.	Description	Mag. Force	Image	Part No.	Description	Mag. Force
	MC-159	Ultra Thin Magnetic Catch	8.8 lbs		MC-JM50BL	Sealed Magnetic Catch	6.6 lbs
	MC-159-SUS	Stainless Steel Ultra Thin Magnetic Catch	11 lbs		MC-JM50WT	Sealed Magnetic Catch	6.6 lbs
	MC-YN001P	Ultra Thin Magnetic Catch w/ Strike Plate	5.9 lbs		MC-JM49	Strike Plate for MC-JM50 & MC-JM45	—
	MC-JM45WT	Sealed Magnetic Catch	6.6 lbs		MCH-80	Heavy Duty Magnetic Catch	





TENSION CATCHES

Image	Part No.	Description	Push/Pull Force	Image	Part No.	Description	Push/Pull Force
	BCT-40	Tension Catch	9.7 lbs / 6.6 lbs		BCTS-40	S/S Tension Catch	4.4 lbs / 2.9 lbs
	BCT-50	Tension Catch	9.0 lbs / 7.3 lbs		BCTS-50	S/S Tension Catch	5.0 lbs / 3.9 lbs
					BCT-70	Tension Catch	10.1 lbs / 7.7 lbs





SLIDE/BARREL BOLTS

Image	Part No.	Description	Finish
	KR-50	S/S Slide Bolt	Satin

PLASTIC CATCHES

Image	Part No.	Description	Push/Pull Force	Image	Part No.	Description	Push/Pull Force
	6900/WHT	Plastic Catch	2.4 lbs / 3.5 lbs		6901/BRN	Plastic Catch	4.8 lbs / 7 lbs
	6901/WHT	Plastic Catch	4.8 lbs / 7 lbs		K-CATCH/WHT-T	Knuckle Catch White	12.5 lbs / 15.6 lbs

NON-MAGNETIC TOUCH LATCHES

Image	Part No.	Description	Retaining Force	Image	Part No.	Description	Retaining Force
	MC-37/BLK-1	Non-Magnetic Touch Latch	17.6 lbs		MC-37/BRN-1	Non-Magnetic Touch Latch	17.6 lbs
	MC-37/WHT-1	Non-Magnetic Touch Latch	17.6 lbs		MC-28/BLK	Non-Magnetic Touch Latch	6.6 lbs
	MLC-100WT	Non-Magnetic Touch Latch (Long Stroke)	13.2 lbs Push force: 2.8lbs				

MAGNETIC TOUCH LATCHES

Image	Part No.	Description	Mag. Force	Image	Part No.	Description	Mag. Force
	ML-80/BRN	Magnetic Touch Latch	3.5 lbs		ML-120/WHT	Long Stroke Mag. Touch Latch	5.2 lbs
	ML-80/BLK ML-80/WHT	Magnetic Touch Latch	3.5 lbs		ML-120/BRN	Long Stroke Mag. Touch Latch	5.2 lbs

DROP/TABLETOP AND PIVOT HINGES

Image	Part No.	Description	Finish	Image	Part No.	Description	Finish
	SDH-001/BLK	Drop Hinge	Black		SDH-P/WT	Drop Hinge	White
	SDH-001/NI	Drop Hinge	Nickel		SMH-83/CR	Table Top Hinge	Chrome
	SDH-P/BL	Drop Hinge	Black		SMH-83/S	Table Top S/S Hinge	Satin
	SDH-P/NI	Drop Hinge	Nickel		PP-L PP-R	Stainless Steel Inset Pivot Hinge L-Left/R-Right	Plain

CONCEALED DOOR HINGES

Image	Part No.	Description	Load Capacity	Image	Part No.	Description	Load Capacity
	HES3D-E190DC (Dull Chrome)	3-Way Adjustable Concealed Hinge	220 lbs/2pcs. 275 lbs/3pcs.		HES3D-120DN (Black)	3-Way Adjustable Concealed Hinge	66 lbs/2pcs. 88 lbs/3pcs.
	HES3D-E190DN (Dull Nickel)	3-Way Adjustable Concealed Hinge	220 lbs/2pcs. 275 lbs/3pcs.		HES3D-90DC (Dull Chrome)	3-Way Adjustable Concealed Hinge	26 lbs/2pcs. 35 lbs/3pcs.
	HES3D-E190BL-UL (Black)	3-Way Adjustable Concealed Hinge	220 lbs/2pcs. 275 lbs/3pcs.		HES3D-90DN (Dull Nickel)	3-Way Adjustable Concealed Hinge	26 lbs/2pcs. 35 lbs/3pcs.
	HES3D-120DC (Dull Chrome)	3-Way Adjustable Concealed Hinge	66 lbs/2pcs. 88 lbs/3pcs.		HES3D-90BL (Black)	3-Way Adjustable Concealed Hinge	26 lbs/2pcs. 35 lbs/3pcs.
	HES3D-120BL (Black)	3-Way Adjustable Concealed Hinge	66 lbs/2pcs. 88 lbs/3pcs.	<p>ALL HES3D and HGS3D HINGES FEATURE:</p> <ul style="list-style-type: none"> • 3-WAY adjustment: vertical, horizontal, and depth. • Covers hide all screw heads for clean appearance. • Hinge leaves separate for easy installation. 			
	HES3D-W190BL-UL (Black) For Cladded Doors	3-Way Adjustable Concealed Hinge	220 lbs/2pcs. 275 lbs/3pcs.	<p>HES2S-140-A125-LGR (Light Gray) HES2S-140-A125-DGR (Dark Gray) HES2S-140-A125-BL (Black)</p>			
	Stainless Steel HGS3D-S160SH (Square covers sold separately)	3-Way Adjustable Concealed Hinge	176 lbs/2pcs. 220 lbs/3pcs.	<p>Surface Mount Concealed Hinge</p> <p>110 lbs/2pcs. 143 lbs/3pcs.</p>			

CONCEALED CABINET HINGES

Image	Part No.	Description	Finish	Image	Part No.	Description	Finish
	J95-24/25T	Heavy Duty Full Overlay Free Swinging Hinge	Load Rating 55 lbs/2pcs. 88 lbs/3pcs.		304B-P4A/32-3W	3Way Adjustable Mounting Plate for 304B Hinge	Polished
	J95-C24/25T	Heavy Duty Full Overlay Self Closing Hinge	Load Rating 55 lbs/2pcs. 88 lbs/3pcs.		304B-P4A/32	Mounting Plate for 304B Hinge	Polished
	J95-P6T	Mounting Plate for J95 Hinge	Nickel		FFCB-HG-1	Face Frame Bracket for 304B Hinge	Nickel
	J95ZC-GR	Mounting Plate Cover for J95-P6T	Grey		R-60	Concealed Hinge	Satin Chrome
	J95-SC-25GR	Hinge Cover for J95-24/25T	Grey		R-70	Concealed Hinge	Satin Chrome
	304B-46/9	S/S Hinge 9mm, Free Swing	Polished		R-100	Concealed Hinge	Satin Chrome
	304B-C46/9	S/S Hinge 9mm, Self Closing	Polished		HES3D-70DC	3-4" 3-Way Adjustable Concealed Hinge	Dull Chrome
	304B-46/19	S/S Hinge 19mm, Free Swing	Polished		HES3D-70DN	3-4" 3-Way Adjustable Concealed Hinge	Dull Nickel
	304B-C46/19	S/S Hinge, 19mm, Self Closing	Polished		HES3D-70BL	1" 3-Way Adjustable Concealed Hinge	Black

DOOR STRAIGHTENERS











DSR213-1524-25	DSR423-1524-25	DSR403-1524-25
Recess Mount	Conceal Mount	Conceal Mount
Available in white finish	Available in plain nickel finish	Available in plain nickel finish

- SLIDING DOOR HARDWARE
- HANDLES
- CATCHES & LATCHES
- HINGES
- LID SUPPORTS
- LATERAL OPENING
- DRAWER SLIDES
- HOOKS
- LEVELING GLIDES
- SHELF & SUPPORT
- DAMPERS
- PANEL MOUNTING

GLASS DOOR HINGES

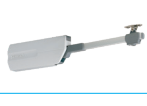
Image	Part No.	Description	Finish	Image	Part No.	Description	Finish
	XL-GH01-600	Inset Glass Door Hinge	Polished		GH-34/0/CR-P	Inset Glass Door Hinge	Chrome
	XL-GH01-250	Inset Glass Door Hinge	Polished		GH-34/0/BL-P	Inset Glass Door Hinge	Black
	XL-GH03-48-8CR	Half Overlay Glass Door Hinge	Chrome		GH-34/8/CR-P	Half Overlay Glass Door Hinge	Chrome
	XL-GH03-48-0CR	Inset Glass Door Hinge	Chrome		GH-34/8/BL-P	Half Overlay Glass Door Hinge	Black
	GHC-34/8/BLK	Half Overlay Glass Door Hinge w/ Catch	Black		GH-34/8/S-P	Half Overlay Glass Door Hinge	Stainless Steel
	GHC-34/8/PB	Half Overlay Glass Door Hinge w/ Catch	Polished Brass		GH-34/0/S-P	Inset Glass Door Hinge	Stainless Steel
	GHC-34/8/CR	Half Overlay Glass Door Hinge w/ Catch	Chrome				

SOFT-DOWN STAYS

Image	Part No.	Description	Torque	Image	Part No.	Description	Torque
	NSDX-10LK NSDX-10RK	Downward Opening Stay (Left, Right)	19~60 lbs/in per piece 38~120 lbs/in per pair		SDS-C100/BLK	Downward Opening Stay (Non-Handed)	30~43 lbs/in per piece 60~86 lbs/in per pair
	NSDX-20LK NSDX-20RK	Top Opening Stay (Left, Right)	19~60 lbs/in per piece 38~120 lbs/in per pair		SDS-C100/WHT	Downward Opening Stay (Non-Handed)	30~43 lbs/in per piece 60~86 lbs/in per pair
	NSDX-35LK NSDX-35RK	Upward Opening Stay (Left, Right)	19~60 lbs/in per piece 38~120 lbs/in per pair		SLS-ELAN-ML SLS-ELAN-MR	Upward Opening Stay (Left, Right)	48~65 lbs/in per piece 96~130 lbs/in per pair
	FFCB-SD-1	Face Frame Bracket for SDS & NSDX Stay	—		SLS-ELAN-HL SLS-ELAN-HR	Upward Opening Stay (Left, Right)	65~87 lbs/in per piece 130~174 lbs/in per pair
	SDS-C301N/ BLK	Top & Upward Opening Stay (Non-Handed)	35~60 lbs/in per piece 70~120 lbs/in per pair		FFCB-SLS	Face Frame Bracket for SLS-ELAN	—
	SDS-C301N/ WHT	Top & Upward Opening Stay (Non-Handed)	35~60 lbs/in per piece 70~120 lbs/in per pair				



FULL EXTENSION DRAWER SLIDES

Image	Part No.	Description	Load Rating	Image	Part No.	Description	Load Rating
	ESR-3813- (8/10/12/14/16/18/20)	S/S 38mm Slide	68~98 lbs		ESR-DC4513- (10/12/14/16/18/20)	S/S 45mm Slide	95~115 lbs







VERTICAL SWING LIFT-UP MECHANISM

Image	Part No.	Description	Door Weight	Image	Part No.	Description	Door Weight
	SLUN-3N	Vertical Swing Lift-Up Mechanism	6.2~8.4 lbs		SLUN-5N	Vertical Swing Lift-Up Mechanism	10.6~12.8 lbs
	SLUN-4N	Vertical Swing Lift-Up Mechanism	8.4~10.6 lbs				



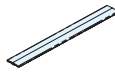
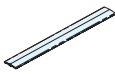
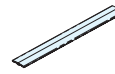
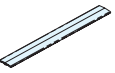

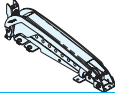
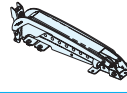
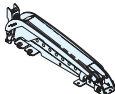
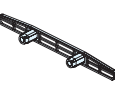
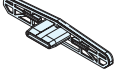





THE AILERON LIFT-ASSIST LID STAY

Image	Part No.	Description	Door Weight	Image	Part No.	Description	Door Weight
	ARN-2-M-S	Top Opening	35.4~53.1 lbs • in		ARN-3-M-S	Upward Opening	35.4~53.1 lbs • in
	ARN-2-H-S		53.1~70.8 lbs • in		ARN-3-H-S		53.1~70.8 lbs • in

LATERAL OPENING

Image	Part No.	Description	Door Dimensions	Image	Part No.	Description	Door Dimensions
	LIN-X1000	Heavy Duty Lateral Opening Door Hinge	W: 29-17/32~43-5/16" H: Max. 117-21/64" Thickness: 15/16~1-37/64" Max. Door Weight: 198lbs/door		LIN-X600	Lateral Opening Door Hinge Set	W: 21-5/8"~25-9/16" H: 23-5/8"~94-1/2" 37.4 lbs
	LIN-X450	Lateral Opening Door Hinge Set	W: 15-3/4"~19-11/16" H: 23-5/8"~94-1/2" 37.4 lbs		LIN-X60-L1740	Connecting Bar L=1740mm	Door Height: 70-7/8"~82-11/16"
	LIN-X450-L1740	Connecting Bar L=1740mm	Door Height: 70-7/8"~82-11/16"		LIN-X60-L2040	Connecting Bar L=2040mm	Door Height: 82-11/16"~94-1/2"
	LIN-X450-L2040	Connecting Bar L=2040mm	Door Height: 82-11/16"~94-1/2"		LIN-X600ACD	Single Arm With Damper	—
	LIN-X450ACD	Single Arm With Damper	—		LIN-X600A	Single Arm Without Damper	—
	LIN-X450A	Single Arm Without Damper	—		LIN-X60C	End Cap for Connecting Bar	—
	LIN-X450C	End Cap for Connecting Bar	—		FFCB-HG-1	Face Frame Bracket for LIN-X	Finish Nickel
	230-P4W-32T	Mounting Plate for LIN-X	Finish Nickel				

HOOKS



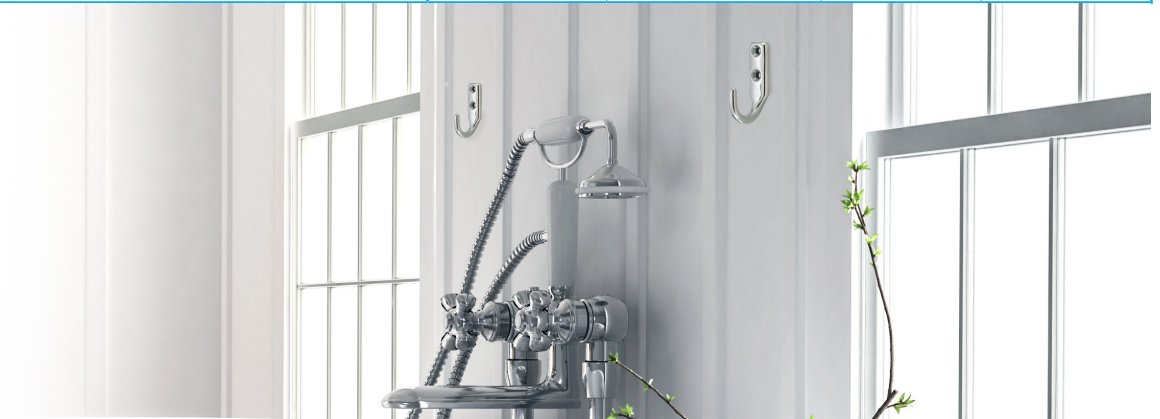

Image	Part No.	Description	Load Capacity	Image	Part No.	Description	Load Capacity
	DSH-01	Coat Hook	22 lbs		TF-20	S/S Hook	6.6 lbs
	EL-25	S/S Hook	44 lbs		TF-30	S/S Hook	15.4 lbs
	EL-30	S/S Hook	44 lbs		TF-35	S/S Hook	26 lbs
	EP-25	S/S Hook	44 lbs		TL-20	S/S Hook	11 lbs
	EP-40	S/S Hook	44 lbs		TL-30	S/S Hook	11 lbs
	HJ-50	S/S Hook	22 lbs		TL-40	S/S Hook	26 lbs
	JF-110	S/S Hook	26 lbs		TY-25	S/S Hook	6.6 lbs
	JF-120	S/S Hook	48 lbs		TY-30	S/S Hook	15.4 lbs
					TY-35-15	S/S Hook	15.4 lbs
Corrosion Resistant Stainless Steel Hooks					TY-40-15	S/S Hook	17.6 lbs





GLIDE

Image	Part No.	Description	Finish
	MN-25	Stainless Steel Leveling Mount with Glide	Satin

BRACKETS

Image	Part No.	Description	Load Capacity	Image	Part No.	Description	Load Capacity
	EB-303/EP	S/S Folding Bracket Black or Polished	660 lbs/pair		EB-317/EP	S/S Folding Bracket	880 lbs/pair
	EB-200	S/S Folding Bracket	770 lbs/pair		EBD	Damper for EB Bracket	-

DAMPERS

Image	Part No.	Description	Torque
	LAD-ST-L	Lift Assist Damper w/ Stopper (Light)	70.8~92.9 lbs-in
	LAD-ST-M	Lift Assist Damper w/ Stopper (Medium)	92.9~119.5 lbs-in
	LAD-ST-H	Lift Assist Damper w/ Stopper (Heavy)	119.5~141.6 lbs-in

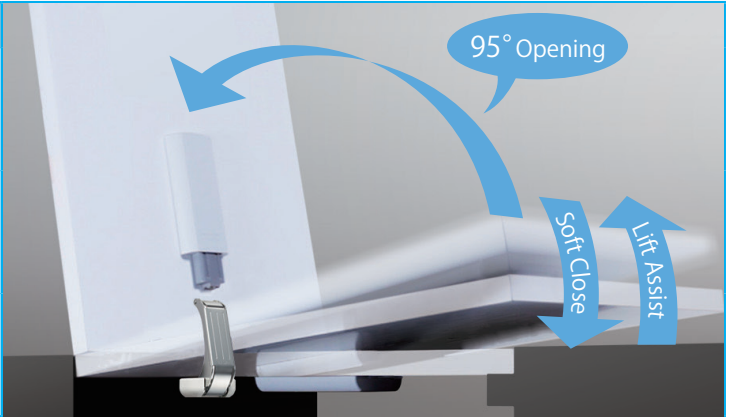

FASTMOUNT-PANEL MOUNTING SYSTEM

Image	Part No.	Description	Image	Part No.	Description
	CT-08	Yard Kit-6 Installation Tools for PC Series		PC-F1A	Panel Clip-Self Tapping Female
				PC-SF1	Panel Clip Surface Mount Female
	PS-S150E	Panel Safe Easy Fit Surface Mount (For Ceiling Panels)		PC-AF1	Panel Clip-Auto Fit Female
	PS-150-E	Panel Safe Easy Fit Self Tapping (For Ceiling Panels)		PC-RF1-B	Panel Clip Side Mount Female
	PC-M1B	Panel Clip Self Tapping Male		VL-03H	Very Low Profile Clip Set (Heavy Duty)
	PC-M2H	Panel Clip-Self Tapping Male Heavy Duty		VL-03	Very Low Profile Clip Set
	PC-SM2	Panel Clip Surface Mount Male		VL-CP3	VLP Center Point with S/S Tip for VL Series
	PC-SM2H	Panel Clip Surface Mount Male Heavy Duty		VL-SS3	Very Low Profile Stainless Steel Screw

- SLIDING DOOR HARDWARE
- HANDLES
- CATCHES & LATCHES
- HINGES
- LID SUPPORTS
- LATERAL OPENING
- DRAWER SLIDES
- HOOKS
- LEVELING GLIDES
- SHELF & SUPPORT
- DAMPERS
- PANEL MOUNTING

sugatsune.com



Sugatsune America
18101 Savarona Way,
Carson, CA 90746
Toll Free: 800-562-5267
sales@sugatsune.com



Midwest Customer Service
1790 W Courland Court
Addison, IL 60101
Phone: 630-371-7072
Fax: 630-519-4107